



DAHAN QTZ125(6513)

HAMMERHEAD CRANE INTRODUCTION

Content

Where QTZ125(6513) Use.....

What QTZ125(6513) Design

What QTZ125(6513) Specification.....

What QTZ125(6513) Advantage.....

QTZ125(6513) Outline Dimensions.....

Load Diagrams 8T.....

Masts.....

Anchorage.....

Mechanisms.....

Counter Weight.....

DAHAN Introduction.....

DAHAN Customers Case.....

125 6513

Advantage

1. With 56,000 sets of market volume and excellent reputation, Dahan tower crane ranks the first place in China tower crane industry in the past decades. Dahan always adheres to the value that supply the most valuable tower crane and service for the customer, with the highest cost performance in the industry.



2. Dahan tower crane owns the leading technology R&D team, the product quality passed several experiments with strict testing. Otherwise, Dahan has 16 years of production technology and rich experiences in quality management. Till now, over 100 national technology patents of tower crane have been put into use already.



3. In order to guarantee the reliability of tower crane quality and reduce the cost, all raw materials are directly supplied by famous brands like Baosteel and Wisco. Raw materials for main parts such as standard section main limbs, tower caps adopt Q345B steel, thus the tensile strength increased by 30% and the tower crane becomes more safe and reliable.

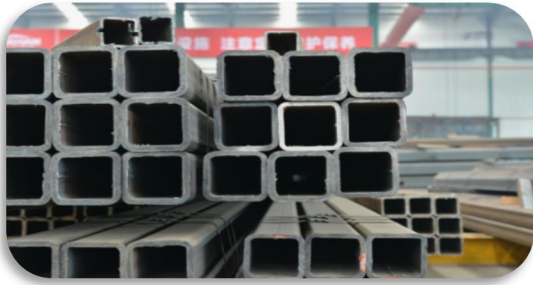

4. Dahan tower crane is the enterprise which firstly started to use the robot welding lines. At present, we have a fully automatic robot welding production line for mast sections fabrication made up by more than 100 welding robots. The production line is composed with automatic material preparation, welding and machining. All main parts of Dahan tower crane use robot welding, with the most advanced carbon dioxide mixed with argon gas shielded welding, it has deep depth of fusion, high quality of welding and stable performance.

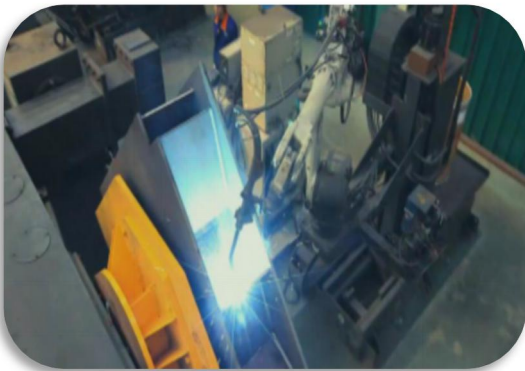

5. All parts and components of Dahan tower crane use premium brands. Electric equipment with Schneider converter, aviation plug, stainless steel distribution box and three linkage console has features of low failure rate and easy installation.

Hoisting mechanism is provided by leading manufacturer Jiangte Motor or Dezhou Shengjian, all with engine oil, free maintenance, high reliability and low maintenance rate.

Slewing support uses Ma'anshan Fangyuan brand or Rothe Erde brand, twice tempering processing makes more smoothly operation and longer tower crane service life.



6. Attention to detail quality. High-strength bolt adopt shipborne scale DACROMET technology. It can keep not rusted for ten years .Swiss screw-thread bolts of preload promote 30 percent than traditional bolts. Weight limiter uses the tension ring structure and cast aluminum shell used Hoisting, derricking limiting stopper to extend service life.

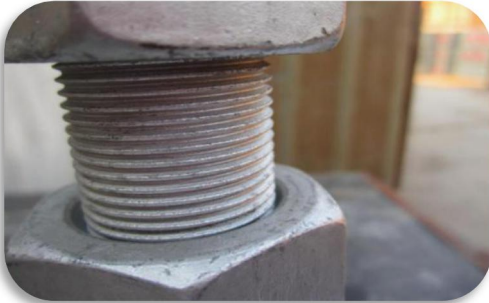

7.Large structures as mast section, turn able, top kit and hoisting jib adopt advanced equipment as NC machine tool, drilling machine, milling machine processing after welding. That effectively guarantees products assembly accuracy, reducing the failure rate and improving the security.



8.12 automatic spraying assembly line, the whole machine adopt impeller blasting to ensure the cleanliness of steel surface and eliminate the internal stress producing in welding process, increase the strength and steel surface hardness, increase painting adhesion. Two primer, a paint spraying technology, beautiful appearance, corrosion resistance has increased more than twice than the life of ordinary spraying process. Platform, the small car, fence and other small pieces adopt hot dip galvanized after acid phosphate treatment, rust resistance stronger.



9. Hoisting, derricking and slewing mechanism, with complete safety such as torque, weight limit. The steel wire rope broken rope device. Range of the car design against loss and broken shaft, such as tilting device. The electrical adopts overload protection, the design of PLC self-diagnosis system, it's convenient to maintenance.

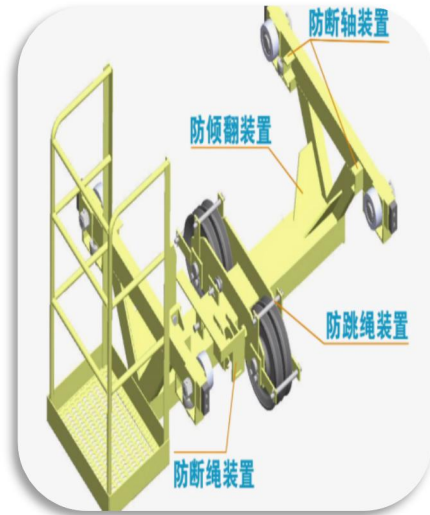





10. Dahan three production bases is Shandong, Hunan, Guangdong. Dahan tower crane are exported to more than 50 countries and regions. We have more than 1000 sets after-sales service network. We carried out the earliest stagnation point service mode in this tower crane industry that ensure the quality of service and efficiency. Otherwise, better to remove customer's worries.

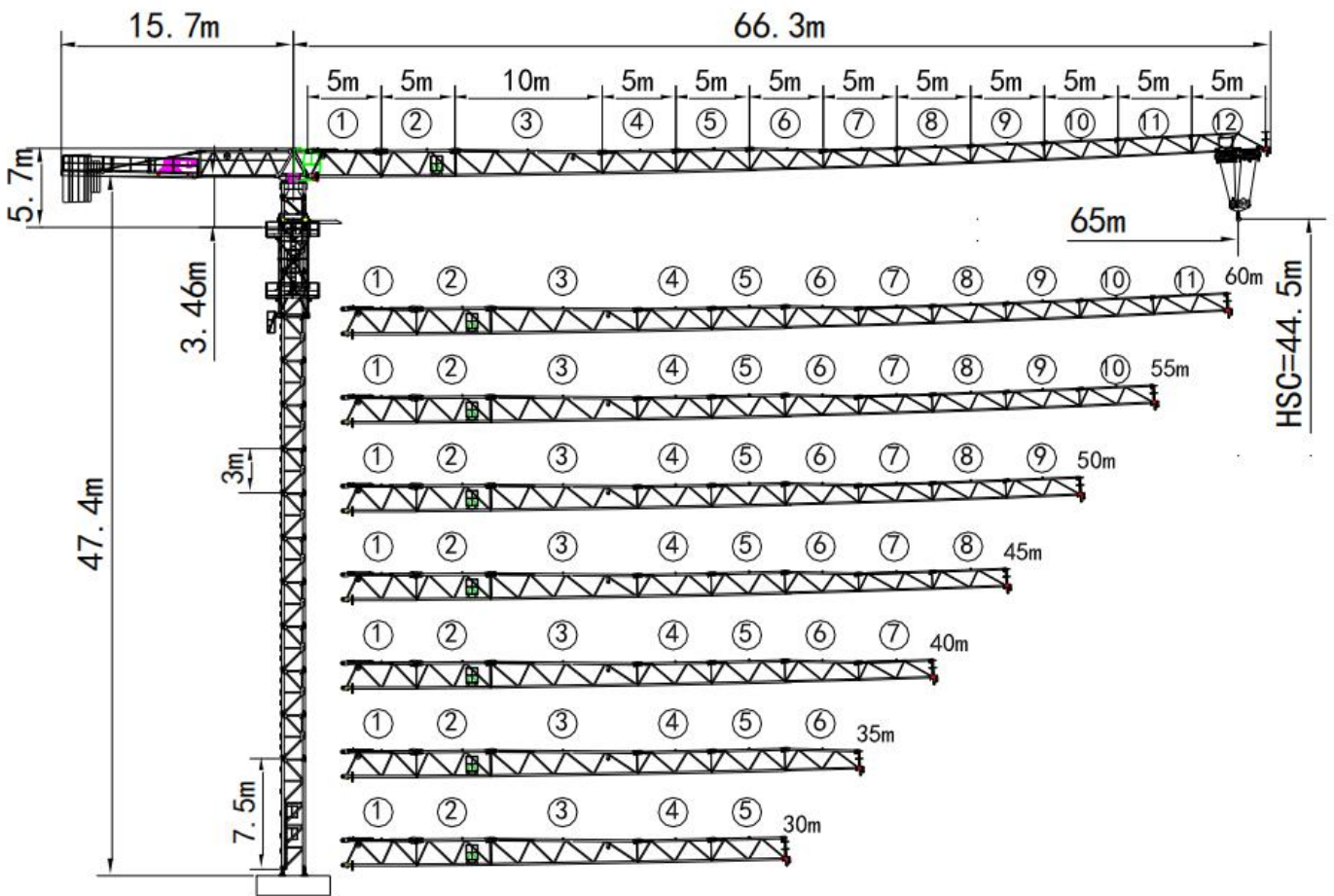





QTZ125(6513) Outline Dimensions



65m

(m)	3-15.3	16	18	20	22	24	26	27.8	28	30	32	35	
Kg		4000								3970	3650	3380	3020
		8000	7570	6600	530	5200	4690	4250	3920	3880	3560	3290	2930
(m)	38	40	42	45	48	50	52	55	58	60	62	65	
Kg		2720	2550	2390	2190	2010	1900	1800	1660	1540	1460	1400	1300
		2630	2460	2300	2100	1920	1810	1710	1570	1450	1380	1310	1210

60m

(m)	3-16.2	18	20	22	24	26	28	29.5	30	32	
kg		4000								3930	3630
		8000	7070	6240	5580	5030	4570	4180	3920	3840	3540
(m)	35	40	42	45	48	50	52	55	58	60	
kg		3250	2750	2590	2370	2170	2060	1950	1810	1680	1600
		3170	2670	2500	2280	2090	1970	1860	1720	1590	1510

55m

		(m)	3-17.3	18	20	22	24	26	28	30	31.7	32
kg	⌋⌋	4000										3970
	⌋⌋⌋	8000	7210	6790	6070	5480	4980	4560	4200	3920	3880	
		(m)	34	35	38	40	42	45	48	50	52	55
kg	⌋⌋	3690	3560	3220	3020	2840	2600	2400	2270	2160	2000	
	⌋⌋⌋	3600	3470	3130	2930	2750	2510	2310	2180	2070	1910	

45m/40/35/30m

		(m)	3-19.3	20	22	24	26	28	30	32
kg	⌋⌋	4000								
	⌋⌋⌋	8000	7710	6900	6240	5680	5210	4800	4440	
		(m)	34	35	35.5	38	40	42	44	45
kg	⌋⌋	4000			3690	3470	3270	3080	3000	
	⌋⌋⌋	4130	3980	3920	3600	3380	3180	3000	2910	

Tower crane performance parameters

Use Level	U5	Maximum Installation Height of Wind Level	≤4				
Load State	Q2	Working state wind level	≤6				
Working Level	A5	Non-working state wind level	≤11				
Parameter Name		Unit	Value				
Rated Load Moment		t.m	125				
Max Load Capacity		t	8				
Max Rated Load Weight Allows Max Ratings		m	15.3				
Working Range (min / max)		m	3-65				
Lifting Height (fixed / attached)		t	1.3				
Rated Load Moment		m	44/200				
Hoisting	Hoisting speed	Fall	/		2		
		Speed	m/min	0~30	0~60	0~15	0~30
		Load Capacity	t	4	2	8	4
	Motor Model		/	YZDPE225L-8			
	Power		Kw	30			
	Motor Speed		r/min	720			
Slewing	Slewing Speed		r/min	0~0.7			
	Power		Kw	2*5.5			
	Speed		r/min	1450			
Trolley	Trolley Speed		m/min	0~65			
	Motor Model		/	YZR132-4			
	Power		kW	5.5			
	Speed		r/min	1450			
Jacking	Jacking Speed		m/min	0.5			
	Hydraulic System Rated Work		MPa	25			
	Motor Model		/	YEZS132m-4			
	Power		kW	7.5			
	Speed		r/min	1470			
	Hydraulic Cylinder by / piston Rod		mm	160/110			
Counterweights	Load Radius		m	65	55	45	
	Counter Weight		t	17.5	15	13.5	
Power		Kw	61.5				

Tower Crane Mechanism Configuration Parameters

	Name		Unit	
	Hoist mechanism	Motor	Model	/
Power			Kw	30
Speed			r/min	720
		Brake Torque	m	630-1250
Reducer		Speed Ratio	/	17.2
Wire Rope		6×36WS+FC- φ 14-1770-I-		
2 times the lowest rate of steady decline ≤ 9m/min				
Slewing mechanism	Motor	Model	/	YTRVFW132M14F1/F2
		Power	Kw	2*5.5
		Speed	r/min	1450
	Reducer	Model	/	JH13
		Speed Ratio	/	162
		Output Torque	N.m	9000
	Output gear parameters	Modulus	M	10
		Gear Number	Z	13
		Displacement Coefficient	X	+0.5
Slewing ring	Single Row Four Point Contact Ball	Model	/	QWA1390.50
		Modulus	M	10
		Gear Number	Z	157
		Displacement Coefficient	X	+0.75
Trolley mechanism	Motor	Model	/	YPBE132-4
		Power	Kw	5.5
		Speed	r/min	1450
	Reducer	Speed Ratio	/	40.7
	Wire Rope	6×19W+FC-7.7-1670-II		
Jacking system	Motor	Model	/	Y132M-4
		Power	Kw	7.5
		Speed	r/min	1470
	Hydraulic Power Station	Flow	L/min	14
		Working Pressure	Mpa	25

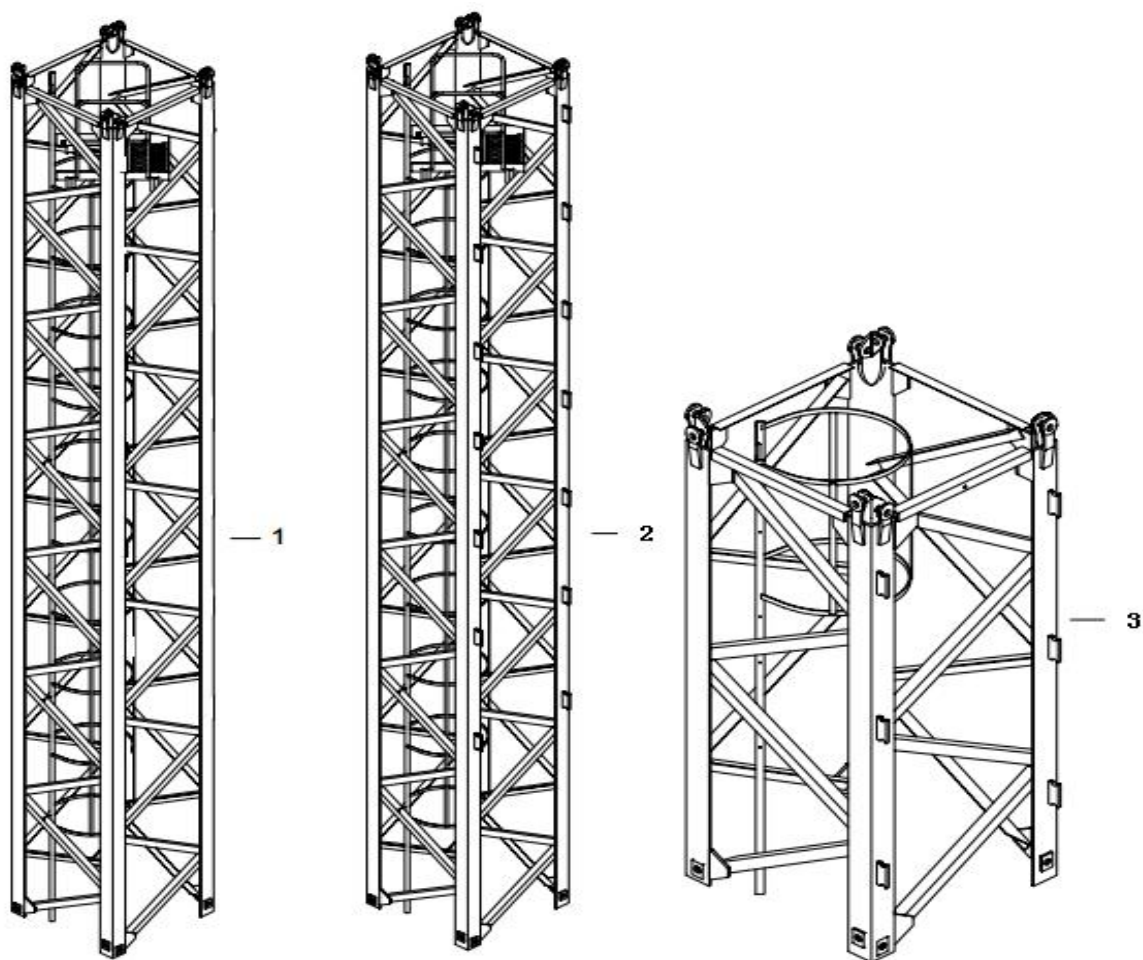

	A	B	C	Weight
	mm	mm	mm	Kg
Base Section 1	1730	1670	7760	3030
Section 3	1700	1700	3260	1180

Climbing Cage

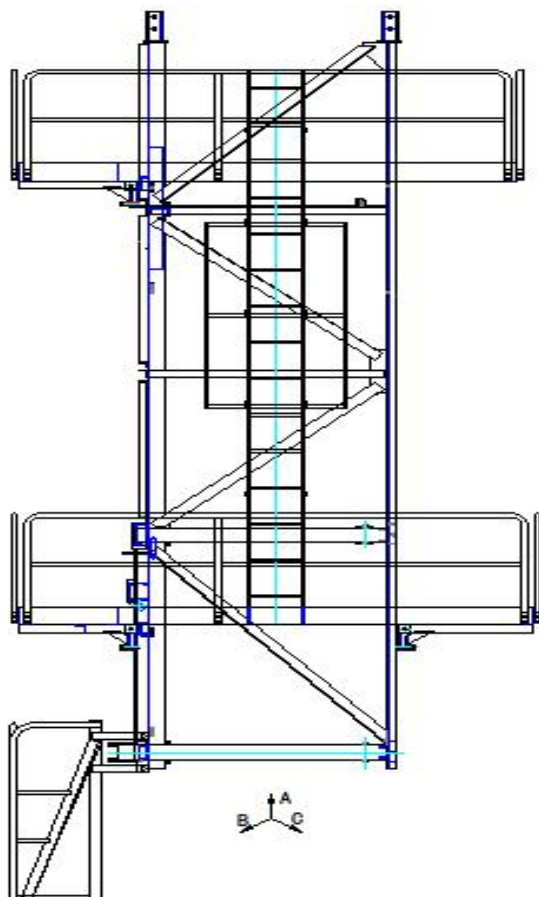

	A	B	C	Weight
	mm	mm	mm	Kg
Climbing Cage Assembly	3585	3585	6785	3405
Skeleton	2320	2100	6785	1760
Jacking Beam	1655	130	579	257
Hydraulic System				600

Slewing Assembly

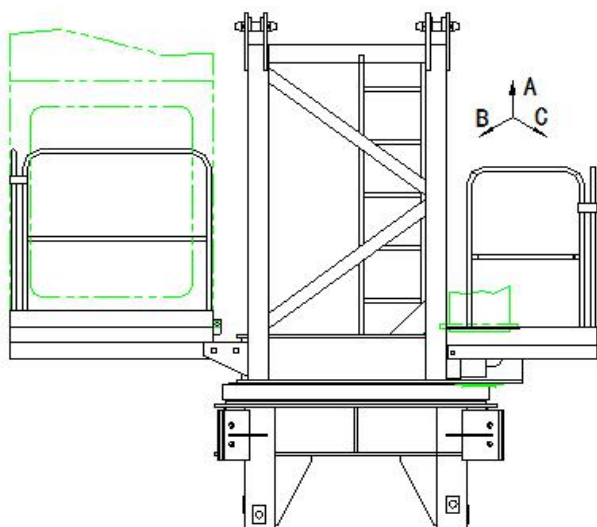

	A	B	C	Weight
				Kg
Slewing assembly	2515	3830	2600	4830
Under turntable	2515	3730	1460	1500
Upper Turntable	1838	1838	1010	1400
Operator cabin				500
Slewing Mechanism				400
Slewing ring				400

Counter jib

	Counter skeletonI	Lever	Electric control box	Hoisting Mechanism	Assembly
A	6835	5755			9315
B	520	595	/	/	1475
C	1197	2220			2220
Kg	689	826	182	1180	3246

Lifting

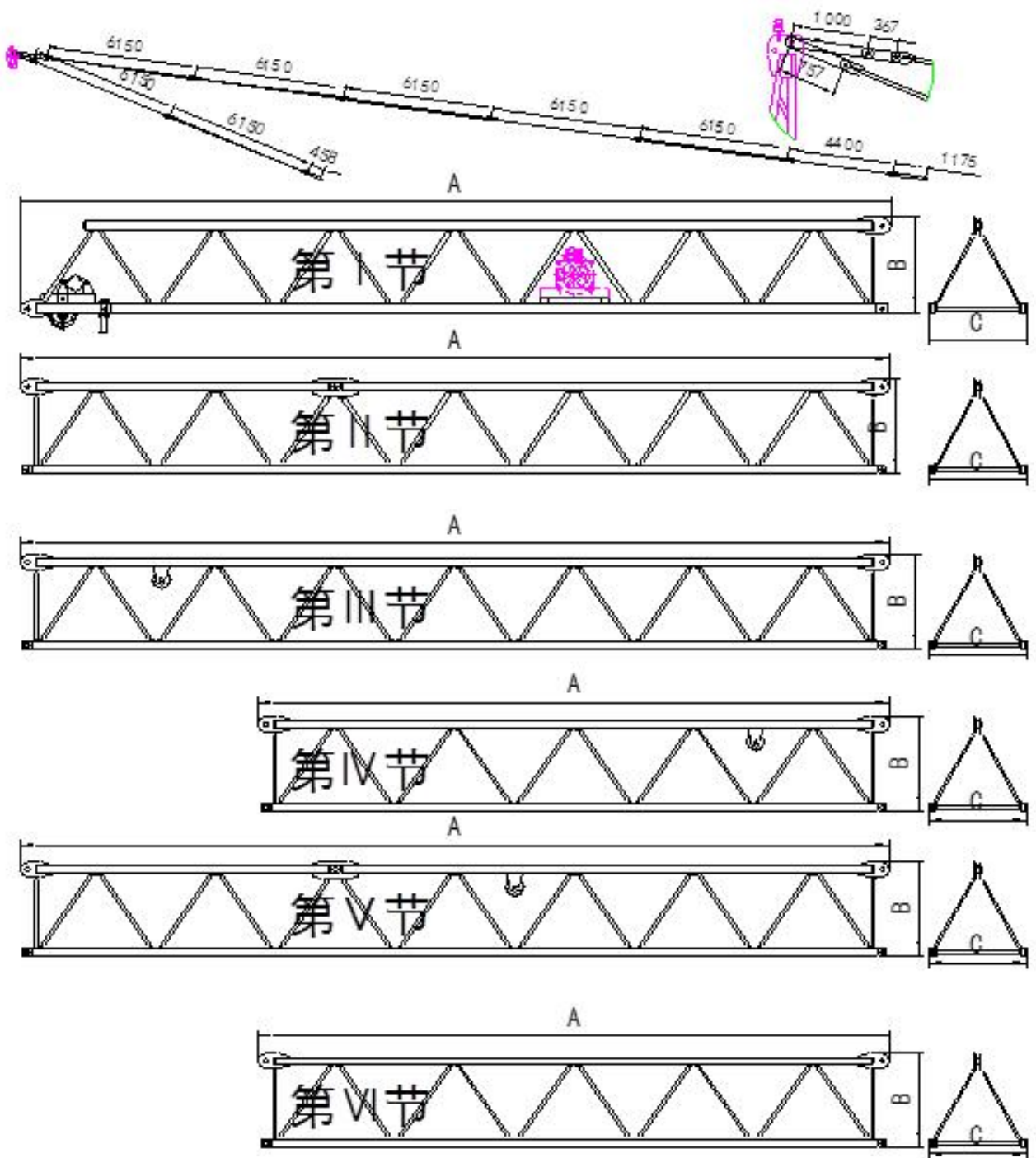



DAHAN Introduction

Dahan Construction Machinery (Group) is a large-scale enterprise group in Chinese construction machinery industry, specializing in the production of "tower cranes" and "construction elevators", with registered capital of 20 million US Dollars, integrating research, development, production, sales, service and finance.

Founded in November, 2000, after 18 years of rapid development, at present, the annual production capacity was over 13,000 sets and become the leading brand in tower crane and elevator industry in China.

The head office of the group is located in Hi-tech Development Zone, Jinan, China, with 3,000 m² workplaces. The production bases are separately located in Mingshui Economic Development Zone of Jinan City, Foshan of Guangzhong Province, Yiyang of Hunan Province, with total area of over 300,000 m². At present the group has 8 production bases, 7 operation center, 8 sales companies, one finance lease company and one import & export company.

Talent strategy is the core competitiveness of Dahan Construction Machinery. Dahan has 2300 employees, and 37 persons of them are cutting-edge technical talents, including drafters of national standard of domestic tower crane industry, engineers of implementing earliest FEM calculation of China, and professionals of design calculation and manufacturing technique. Besides, the group also have more than 600 professional personnels of other aspects like sales, management, financing, etc..

Science and technology are primary productive forces. Dahan owns 82 national technology patents (including 5 invention patent. In 2013 the group won the "high-tech enterprise" title, joined the Chinese Hoisting Machinery Standardization Technical Committee, and participated in revision of national standard (GB13752) of tower crane.

At present, the company has imported more than 100 robots of Panasonic and ABB company from Japan and Sweden separately, and owns 12 sets of automatic spraying lines, more than 1000 sets of large plasma cutting machines, CNC drilling machines, milling machines, lathes, boring machines, welding machine and other special tools and equipment. Through advanced equipment, automated assembly line, Dahan can ensure quality of products in the aspect of production technology. Besides, Dahan also build strategic partnership and matching supply cooperation with world-class enterprises such as Baosteel, Ansteel, Dezhou Sheng Jian, Rothe Erde, SIEMENS, Zhejiang Sanmen, France Schneider, etc., to ensure fist class quality of products in the aspect of purchasing of raw material and spare parts.

Now the group has achieved complete coverage of four major series, i.e., top kit tower crane, flat-top tower crane, luffing boom tower crane, and construction hoist, with over 30 types and more than 60 models. Till 2019, Dahan had built sales teams of 2000 persons, and nearly 1000 sales outlets in domestic market, and sold nearly 50,000 Dahan tower cranes to 32 provinces, direct-controlled municipalities, and autonomous region, and exported products to over 50 countries and districts.



In 2012, Dahan established the joint venture, Zhongkang International Financial Leasing Co., Ltd in Binhai New Area, Tianjin City, with 50 million dollars registered capital, to effectively provide clients financing solutions, aiming to achieve the transition of sales modes from “Products supply” to “Supply of products and comprehensive financing service”.

Along with internationalization and implementation of international branding strategy, Dahan Construction Machinery (Group) has developed to be a professional, mature, healthy and highly reliable manufacturer and service provider of tower cranes and construction hoists, and will stand on the top of world’s construction machinery industry with a fire-new image.